

## 1.1.1.6 Integrating Spheres

### 1.1.1.6.4 Large Dimensions 5.3"

#### Features

- 4 port Integrating spheres for collimated and divergent beams (LEDs, VCSELs, etc.)
- Up to 170° acceptance angle
- Ø63.5mm (2.5") aperture
- Fiber or free space input
- Can be ordered with or without detectors

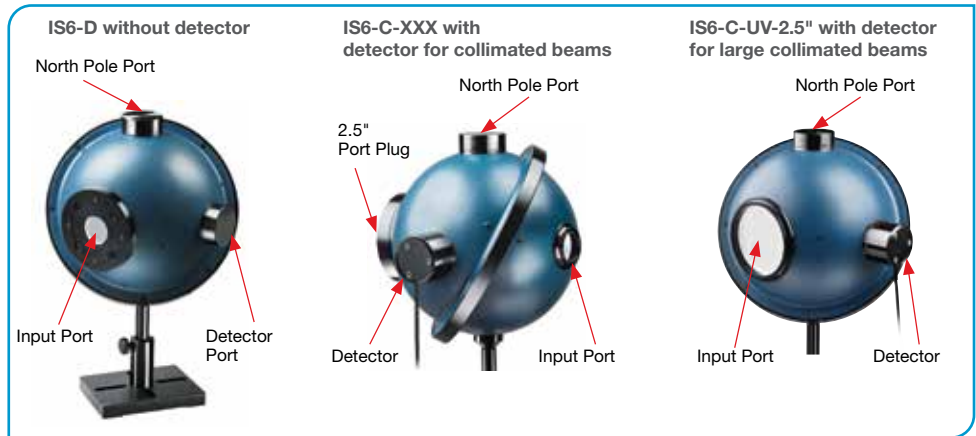

Model	IS6		
Use	For use with customer detector or as light source		
Detector	None – see below for detector versions		
Spectral Range $\mu\text{m}$	0.2 – 2.2		
Source Geometry <sup>(a)</sup> (see introduction)	<b>Divergent</b>	<b>Collimated</b>	
Input Port Aperture mm	Ø63.5 <sup>(b)</sup>	Ø25	
Maximum Beam Divergence deg°	$\pm 60$ <sup>(d)</sup>	$\pm 15$	
Sensitivity to Beam Divergence $\pm\%$	3 <sup>(c)</sup>	1	
Power Range	Depends on detector – see below		
Damage Threshold $\text{kW}/\text{cm}^2$	1 on integrating sphere surface		
Cooling	Convection		
Weight kg	1.4		
Type	P/N	Version	Compliance
IS6-D For divergent beams (input from 2.5" side)	7Z02487	V1	RoHS, China RoHS
IS6-C For collimated beams (input from 1" side)	7Z02474		RoHS, China RoHS
<b>Supplied Port Accessories</b> (see page 40)	<b>IS6-D:</b> 2.5" to 1" reducer w/cover + 1" port plug + 2 ea. 1" port covers <b>IS6-C:</b> 2.5" port plug + 3 ea. 1" port covers		

Notes: (a) In each configuration, the opposing port is closed with a port plug. See diagram in introduction page 34.  
(b) The sphere is supplied with the 2.5" to 1" reducer.  
(c) For beams up to 30deg divergence, variation with beam size is  $\pm 1\%$ .  
(d) For central 5mm of aperture, for 10mm aperture maximum beam divergence is  $\pm 66^\circ$ .

#### IS6 with Detectors for Collimated Beams - calibrated - VIS, UV & IR types

-Recommended for beam divergence  $< 15^\circ$

-Comes with calibrated wavelength curve

Model	IS6-C-VIS		IS6-C-UV		IS6-C-IR		IS6-C-UV-2.5"	
Detector type	VIS		UV		IR		UV	
Use	High powers		Low powers		Low powers		Large beams	
Type	Si with filter		Si		Germanium		Si	
Spectral Range $\mu\text{m}$	0.4 – 1.1		0.2 – 1.1		0.7 – 1.8		0.2 – 1.1	
Power Range (approx.)	20 $\mu\text{W}$ to 30W		300nW to 1W		100 $\mu\text{W}$ to 30W		300nW to 2W	
Power Scales	30W to 300 $\mu\text{W}$		1W to 3 $\mu\text{W}$		30W to 300 $\mu\text{W}$		2W to 3 $\mu\text{W}$	
Linearity with Power $\pm\%$	1							
Power Noise Level	1 $\mu\text{W}$		15nW		5 $\mu\text{W}$		15nW	
Calibration Uncertainty $\pm\%$	1.1 430-1000nm <sup>(b)</sup>		1.1 430-1000nm <sup>(b)</sup>		2.4 700-1430nm <sup>(b)</sup>		1.1 430-1000nm <sup>(b)</sup>	
Maximum Pulse Energy mJ	5		0.1		0.3		0.3	
Input Port Aperture mm	Ø25						Ø63.5	
Sensitivity to Beam Size %	$\pm 1$						$\pm 1$ <sup>(a)</sup>	
Maximum Power vs. Wavelength	nm	W	nm	W	nm	W	nm	W
	<670	30	<600	0.7	<1400	30	<600	1.5
	790	20	800-1000	0.3	1400-1650	15	800-1000	1
	904	15	1064	0.5	>1650	30	1064	2
	1064	25						
Accuracy vs Wavelength	nm	%	nm	%	nm	%	nm	%
	360 - 410	$\pm 10$	200 - 270	$\pm 10$	700-1650	$\pm 5$	200 - 270	$\pm 10$
	410 - 950	$\pm 5$	270 - 950	$\pm 5$	1650-1800	$\pm 7$	270 - 950	$\pm 5$
	950 - 1100	$\pm 7$	950 - 1100	$\pm 7$			950 - 1100	$\pm 7$
Compliance	CE, UKCA, China RoHS		CE, UKCA, China RoHS		CE, UKCA, China RoHS		CE, UKCA, China RoHS	
Part Number	7Z02470		7Z02472		7Z02476		7Z02485	
<b>Supplied Port Accessories</b> (see page 40)	<b>IS6-C-XXX:</b> 2.5" port plug + 2 ea. 1" port covers <b>IS6-C-UV-2.5":</b> 2.5" port cover + 1" port plug + 1" port cover							

Notes: (a) Over central 40mm,  $\pm 2\%$  over central 50mm  
(b) For calibration uncertainty of wavelengths outside of this range see table on page 24

#### Incorporated Detectors: IS6-C-VIS / IS6-C-UV IS6-C-IR / IS6-C-UV-2.5"

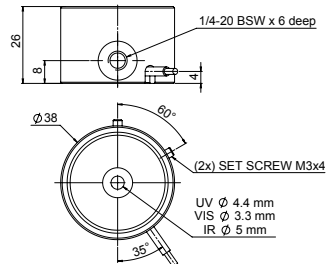

#### IS6

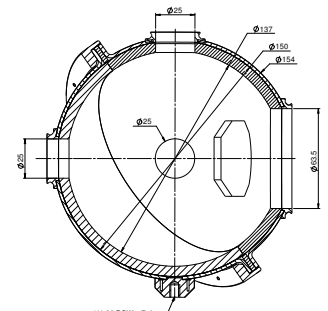

**IS6-D-XXX with detector for divergent beams**

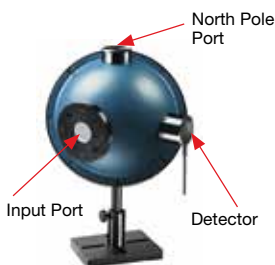

**IS6-D-IR-170 with detector for highly divergent beams up to 170°**

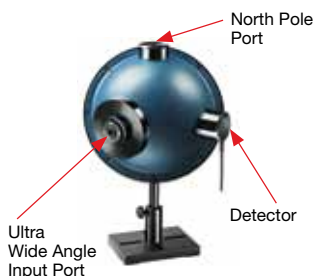

**FPD Detector Mounted on IS6-D-IR-170**

Ophir FPD fast photodiode detectors (see page 143) interface with all IS6 integrating spheres, facilitating temporal characterization of laser pulses in parallel with other measurements.



**IS1.5-VIS-FPD-800**

**Related Product**  
For an integrating sphere sensor that has an FPD pulse characterization detector built in, see our **IS1.5-VIS-FPD-800, 1.5" High Speed Response, Multi-functional Integrating Sphere** on page 36.



**IS6 with Detectors for Divergent Beams– calibrated – VIS, UV & IR types**

- Recommended for beam divergence 15° to 120°
- High divergence model for large angles up to 170°
- Comes with calibrated wavelength curve

Model	IS6-D-VIS		IS6-D-UV		IS6-D-IR		IS6-D-IR-170	
Detector type	VIS		UV		IR		IR	
Use	High powers for divergent beams		Low powers for divergent beams		Low powers for divergent beams		Low powers for highly divergent beams (up to 170°)	
Type	Si with filter		Si		Germanium		Germanium	
Spectral Range μm	0.4 – 1.1		0.2 – 1.1		0.7 – 1.8		0.7 – 1.8	
Power Range (approx.)	20μW to 30W		300nW to 1W		100μW to 30W		20μW to 30W	
Power Scales	30W to 300μW		1W to 3μW		30W to 300μW		30W to 300μW	
Linearity with Power ±%	1		1		1		1	
Power Noise Level	1μW		15nW		5μW		1μW	
Calibration Uncertainty ±%	1.1 430-1000nm (c)		1.1 430-1000nm (c)		2.4 700-1430nm (c)		2.4 700-1430nm (c)	
Maximum Pulse Energy mJ	5		0.15		0.3		0.7	
Maximum Beam Divergence deg°			±60 (b)				> ±85	
Input Port Aperture mm			Ø26				Ø8	
Sensitivity to Beam Divergence ±%			3 (a)				1.5	
Maximum Power vs. Wavelength	nm	W	nm	W	nm	W	nm	W
	<670	30	<600	1	<1400	30	700-1800	30
	790	30	800-1000	0.5	1400-1650	15		
	904	20	1064	1	>1650	30		
	1064	30						
Accuracy vs Wavelength	nm	%	nm	%	nm	%	nm	%
	360 - 410	±10	200 - 270	±10	700-1650	±5	700-1650	±5
	410 - 950	±5	270 - 950	±5	1650-1800	±7	1650-1800	±7
	950 - 1100	±7	950 - 1100	±7				
Compliance	CE, UKCA, China RoHS		CE, UKCA, China RoHS		CE, UKCA, China RoHS		CE, UKCA, China RoHS	
Version	V1		V1		V1			
Part Number	7Z02488		7Z02489		7Z02490		7Z02486	
Supplied Port Accessories (see page 40)	<b>IS6-D (with detector):</b> 2.5" to 1" reducer w/cover + 1" port plug + 1" port cover <b>IS6-D-IR-170:</b> 2.5" to 1" reducer with 170° attachment and cover + 1" port plug + 1" port cover							

Notes: (a) For beams up to 30° divergence, variation is ±1%  
 (b) For central 6mm of aperture, for 12mm aperture maximum beam divergence is ±50°  
 (c) For calibration uncertainty of wavelengths outside of this range see table on page 24

**Incorporated Detectors:**  
**IS6-D-VIS / IS6-D-UV / IS6-D-IR**

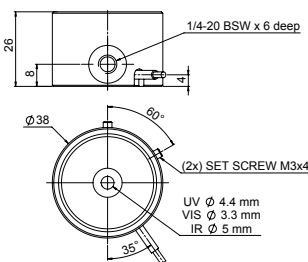

**IS6**

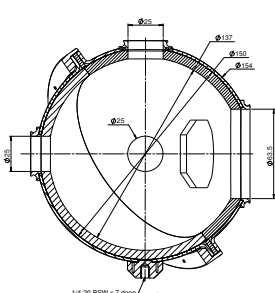

**IS6-D-IR-170**

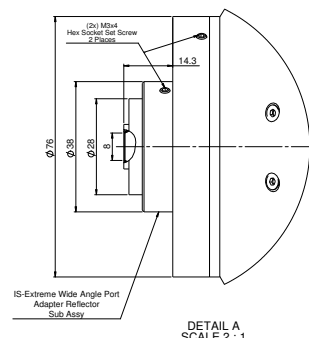
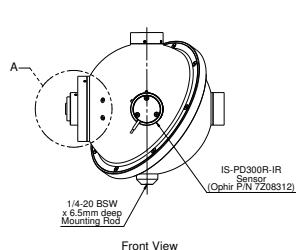

### 1.1.1.6.5 Accessories for IS6

All accessories can be attached to 1" ports unless otherwise noted.

Accessory	Description	Part number
<b>Port plugs</b>		
IS-1" Port plug	Port plugs close ports with white sphere material, eliminating the port from the sphere geometry	
IS-1" Port plug	White reflectance material, PTFE, Ø25.4mm plug	7Z08280A
IS-2.5" Port plug	White reflectance material, PTFE, Ø63.5mm plug, for 2.5" port	7Z08283A
<b>Port Covers</b>		
	Port Covers close ports with a black matte surface. They prevent extraneous light from entering the sphere without changing the sphere configuration. These covers can also be used as blanks for making specialized port adapters	
IS-1" Port cover	Matte black coated Ø25.4mm cover	7Z08282A
IS-2.5" Port cover	Matte black coated Ø63.5mm cover, for 2.5" port	7Z08281A
<b>Adapters and Reducers</b>		
	The adapters are black coated and the reducers white coated	
1" SMA fiber adapter	SMA fiber input/output	7Z08285
1" FC fiber adapter	FC fiber input/output	7Z08286
FPD (except FPS-1) to IS6 adapter	For mounting FPD sensor series to North Pole port of IS6 series	7Z08350
1" to SM1 adapter	Female SM1 thread, used for attaching FPS-1 detector to IS6	7Z08289
2.5" to 1" port reducer	Convert the 2.5" port into a 1" port PTFE	7Z08305A
Set of aperture masks	Ø5, Ø7, Ø10mm apertures, for use with 2.5" to 1" port reducer P/N 7Z08305A <sup>(a)</sup> <sup>(c)</sup>	7Z08307
Flange attachment	Dovetail flange for use with 2.5" to 1" port reducer P/N 7Z08305A <sup>(b)</sup> <sup>(c)</sup>	7Z08306

Notes: (a) This accessory is held on to port reducer 7Z08305A magnetically.  
 (b) This accessory is mounted to port reducer 7Z08305A with the included screws.  
 (c) IS6 P/N's 7Z02471, 7Z02473, 7Z02475, 7Z02477 incorporate an earlier version of the 2.5" to 1" port reducer that is not compatible with this accessory. That port reducer can be replaced with the current version, P/N 7Z08305A, in order to use the new accessories.

