

3.3.4.4.1 Pyroelectric Array Cameras

Pyrocam™ IIIHR & Pyrocam™ Series

Features

- Spectral ranges available from 13 to 355nm and 1.06 to >3000µm
- Image CO2 lasers, telecom NIR lasers, THz sources and other infrared sources out to Far IR
- Solid state array camera with 1000:1 linear dynamic range for accurate profiling
- Integrated chopper for CW beams and thermal imaging
- Interchangeable windows available for a variety of applications
- Includes BeamGage® Laser Beam Analysis Software for quantitative analysis and image display



Model	Pyrocam IIIHR		Pyrocam IV					
Application	UV and IR	MIR ⁽¹⁾	UV and IR	MIR ⁽¹⁾				
Wavelengths	13 - 355nm	3 - 5µm	13 - 355nm	3 - 5µm				
	1.06 - 3000µm		1.06 - 3000µm					
Interchangeable windows	See selection in Ordering section		See selection in Ordering section					
Detector array details								
Active area	12.8mm x 12.8mm		25.6mm x 25.6mm					
Beam sizes ⁽²⁾	1600µm - 12.7mm		1600µm - 25.4mm					
Pixel spacing	80µm x 80µm		80µm x 80µm					
Number of effective pixels	160 x 160		320 x 320					
Pixel size	75µm x 75µm		75µm x 75µm					
Chopped CW operation								
Chopping frequencies	25Hz, 50Hz		25Hz, 50Hz					
Lowest measurable signal	64nW/pixel or 1.0 mW/cm ² (25Hz) 96nW/pixel or 1.5 mW/cm ² (50Hz)		64nW/pixel (25Hz) or 1.0mW/cm ² (25Hz) 96nW/pixel (50Hz) or 1.5mW/cm ² (50Hz)					
Noise equivalent power (NEP)	13nW/Hz ^{1/2} /pixel (1Hz)		13nW/Hz ^{1/2} /pixel (1Hz)					
Saturation intensity (25Hz, 50Hz)	3.0W/cm ² , 4.5W/cm ²		3.0W/cm ² , 4.5W/cm ²					
Damage threshold power								
Over entire array	2W		2W					
Peak Power Density	8W/cm ² (Chopped mode) 4W/cm ² (CW in pulsed mode)		8W/cm ² (Chopped mode) 4W/cm ² (CW in pulsed mode)					
Pulsed operation								
Laser pulse rate	Single-shot to 1000Hz		Single-shot to 1000Hz					
Pulse width	1fs - 12.8ms		1fs - 12.8ms					
Lowest measurable signal	0.5nJ/pixel		0.5nJ/pixel					
	8µJ/cm ²		8µJ/cm ²					
Saturation energy	15mJ/cm ²		15mJ/cm ²					
Damage threshold	20mJ/cm ² (1ns pulse) 600mJ/cm ² (1µs pulse)		20mJ/cm ² (1ns pulse) 600mJ/cm ² (1µs pulse)					
Trigger input								
High logic level	3.5 - 6.0V DC		3.5 - 6.0V DC					
Low logic level	0 - 0.8V DC		0 - 0.8V DC					
Pulse width	4µs min		4µs min					
Trigger	Supports both trigger and strobe out		Supports both trigger and strobe out					
Photodiode trigger (Optional) ⁽³⁾	InGaAs response: SP90409		InGaAs response: SP90409					
Operating & conditions								
Power	12VDC		12VDC					
Line frequency	60/50Hz External Supply		60/50Hz External Supply					
Power consumption	12W		12W					
Operating temperature	5°C to 50°C		5°C to 50°C					
Physical								
Dimensions	140mm H X 130mm W X 60mm D		147.3mm H X 147.1mm W X 55.2mm D					
Detector Position	Centered in width 35.6mm from bottom 15.15 ± .75mm behind front cover (without included C-mount attached) Tilt <2°		53.8mm from bottom left 36.8mm from bottom 19.7 ± .75mm behind front cover Tilt <2°					
Weight	0.85Kg (1.83lbs)		1.2kg (2.65lbs)					
PC interface	Gigabit Ethernet (IEEE 802.3ab), GigE Vision compliant		Gigabit Ethernet (IEEE 802.3ab), GigE Vision compliant					
OS supported	Windows 7 (64) and Windows 10		Windows 7 (64) and Windows 10					
Compliance	CE, UKCA, China RoHS		CE, UKCA, China RoHS					
Array quality								
	<75 bad pixels, all correctable No uncorrectable clusters		<300 bad pixels, all correctable No uncorrectable clusters					
Ordering information								
Supported software	Item	P/N	Item	P/N	Item	P/N	Item	P/N
BeamGage Professional	PY-III-HR-C-A-PRO	SP90405 ⁽⁴⁾	PY-III-HR-C-MIR-PRO	SP90415 ⁽⁴⁾	PY-IV-C-A-PRO	SP90404 ⁽⁵⁾	PY-IV-C-MIR-PRO	SP90414 ⁽⁵⁾

Notes: (1) The MIR (Mid-IR) versions on the Pyrocam IIIHR and IV are designed specifically for Mid-IR lasers in the spectral range 3 to 5µm. The MIR versions feature specifically designed sensors that maximize the optical signal for high fidelity spatial profile measurements of laser beam in the 3 to 5µm spectral range. (2) The maximal beam size refers to "Flat-top" laser beams. For Gaussian beams, reduce maximum beam size by 1/3. (3) For more information please see "Optical Camera Trigger" catalog page. (4) Comes with USB 3.0 cable to Gigabit Ethernet Adaptor, CAT6 Ethernet Cable, Trigger cable SMA to BNC, power supply with locking connector, and adapter Kit for C-Mount Lens. (5) Comes with USB 3.0 cable to Gigabit Ethernet Adaptor, CAT6 Ethernet Cable, Trigger cable SMA to BNC and power supply with locking connector.

* For drawings and accessories ordering information please see page 238

Pyrocam IIIHR

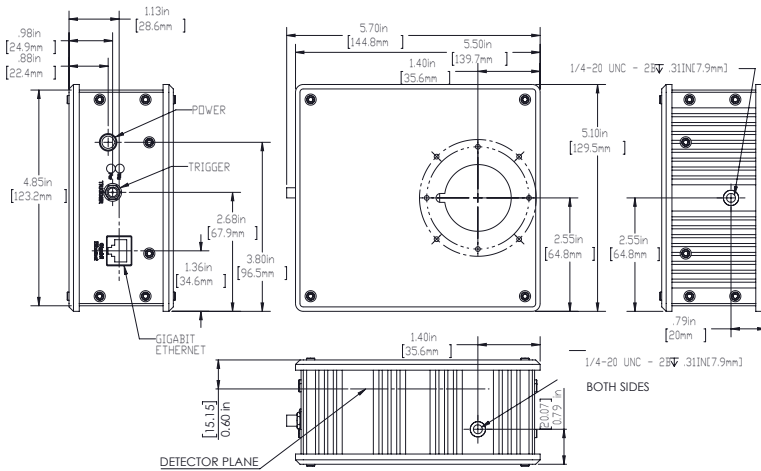

Pyrocam IV

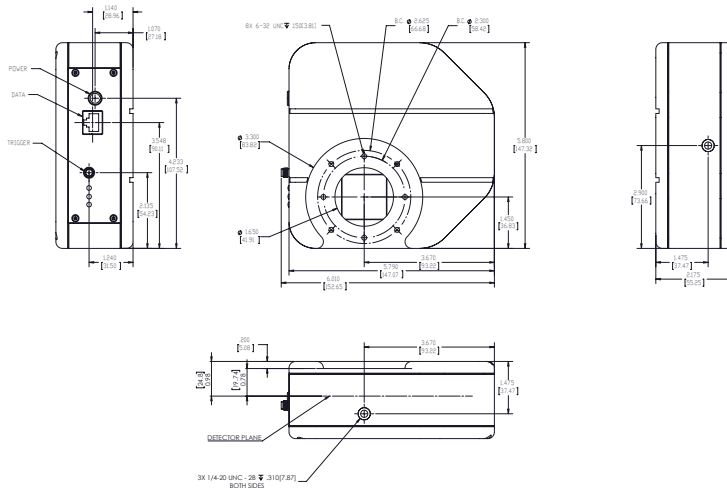

Accessories Ordering Information

Item	Description	P/N
Optional windows for Pyrocam™ IIIHR		
PY-III-HR-W-BK7-1.064	Pyrocam III-HR window assembly, BK7, A/R coated for 1.064µm	SP90365
PY-III-HR-W-SI-1.05-2.5	Pyrocam III-HR window assembly, Si, A/R coated for 1.05 to 2.5µm	SP90366
PY-III-HR-W-SI-2.5-4	Pyrocam III-HR window assembly, Si, A/R coated for 2.5 to 4µm	SP90367
PY-III-HR-W-GE-3-5.5	Pyrocam III-HR window assembly, Ge, A/R coated for 3 to 5.5µm	SP90368
PY-III-HR-W-GE-10.6	Pyrocam III-HR window assembly, Ge, A/R coated for 10.6µm	SP90369
PY-III-HR-W-GE-8-12	Pyrocam III-HR window assembly, Ge, A/R coated for 8 to 12µm	SP90370
PY-III-HR-W-ZNSE-10.6	Pyrocam III-HR window assembly, ZnSe, A/R coated for 10.6µm	SP90371
PY-III-HR-W-ZNSE-10.2µm & 10.6µm	Pyrocam III-HR window assembly, ZnSe, A/R coated for 10.2µm & 10.6µm	SP90412
PY-III-HR-W-ZNSE-2-5	Pyrocam III-HR window assembly, ZnSe, A/R coated for 2 to 5µm	SP90372
PY-III-HR-W-BaF2-Uncoated	Pyrocam III-HR window assembly, BaF2 uncoated for 193 to 10µm	SP90373
PY-III-HR-W-POLY-THZ	Pyrocam III-HR window assembly, LDPE, uncoated for Terahertz wavelengths	SP90374
Optional windows for Pyrocam™ IV		
PY-IV-W-BK7-1.064	Pyrocam IV window assembly, BK7, A/R coated for 1.064µm	SP90301
PY-IV-W-SI-1.05-2.5	Pyrocam IV window assembly, Si, A/R coated for 1.05 to 2.5µm	SP90302
PY-IV-W-SI-2.5-4	Pyrocam IV window assembly, Si, A/R coated for 2.5 to 4µm	SP90303
PY-IV-W-GE-3-5.5	Pyrocam IV window assembly, Ge, A/R coated for 3 to 5.5µm	SP90304
PY-IV-W-GE-10.6	Pyrocam IV window assembly, Ge, A/R coated for 10.6µm	SP90305
PY-IV-W-GE-8-12	Pyrocam IV window assembly, Ge, A/R coated for 8 to 12µm	SP90306
PY-IV-W-ZNSE-10.6	Pyrocam IV window assembly, ZnSe, A/R coated for 10.6µm	SP90307
PY-IV-W-ZNSE-2-5	Pyrocam IV window assembly, ZnSe, A/R coated for 2 to 5µm	SP90308
PY-IV-W-ZNSE-Uncoated	Pyrocam IV window assembly, ZnSe, uncoated	SP90336
PY-IV-W-POLY-THZ	Pyrocam IV window assembly, LDPE, uncoated for Terahertz wavelengths	SP90309

3.3.4.4 13-355nm and 1.06-3000µm Cameras

Pyroelectric Technology

Spiricon has been the world leader in the manufacture of pyroelectric solid-state detector arrays and cameras. For over 25 years the Pyrocam™ has been the overwhelming camera of choice for Laser Beam Diagnostics of IR and UV lasers and high temperature thermal imaging. Precision, stability, reliability, and versatility have become its proud heritage.

The Pyrocam IIIHR offers a 1/2X1/2 inch detector array with easy Windows® camera setup and quantitative image display through the BeamGage software, 16 bit digitizer, versatile Gigabit Ethernet PC interface, and an integral chopper for CW beams and thermal imaging.

The Pyrocam IV offers a 1X1 inch detector array with easy Windows® camera setup and quantitative image display through the BeamGage software, 16 bit digitizer, with a high-speed Gigabit Ethernet PC interface, and an integral chopper for CW beams and thermal imaging.

See Your Beam As Never Before

Both Pyrocam™ cameras create clear and illuminating images of your laser beam profile. Displayed in 2D or 3D views, you can immediately recognize beam characteristics that affect laser performance and operation. This instantly alerts you to detrimental laser variations. Instantaneous feedback enables timely correction and real-time tuning of laser parameters. For example, when an industrial shop foreman saw the CO₂ laser beam profile in Figure 1 he knew immediately why that laser was not processing materials the same as the other shop lasers, that had similar profiles shown in Figure 2.

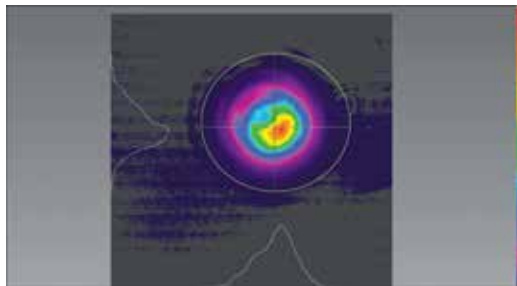

2D CO₂ laser beam

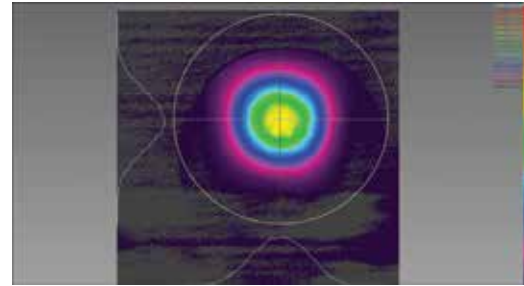

2D CO₂ laser beam

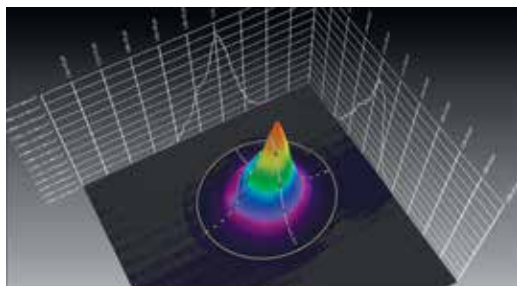

3D CO₂ laser beam

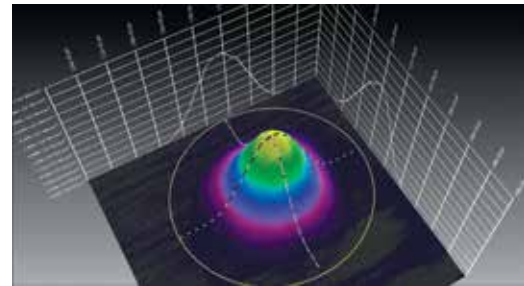

3D CO₂ laser beam

Figure 1 - Distorted spot, not good for material processing

Figure 2 - Good spot for material processing

Pulsed and CW Lasers

The Pyrocams measure the beam profile of both pulsed and CW lasers. Since the pyroelectric crystal is an integrating sensor, pulses from femtosecond to 12.8ms can be measured. The pyroelectric crystal only measures changes in intensity, and so is relatively immune to ambient temperature changes. Because CW laser beams must be chopped to create a changing signal, the Pyrocam™ contains an integral chopper.

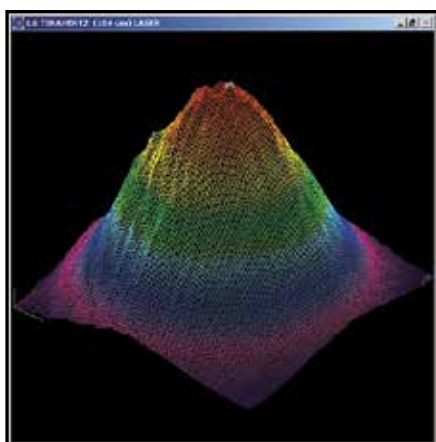

Pyrocam III imaging THz laser beam at 0.2THz (1.55mm) 3mW input power; 19 frames summed

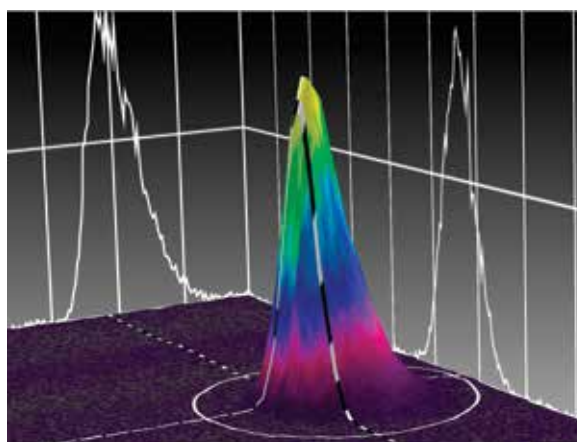

Pyrocam IV imaging THz laser beam 0.5 THz (5mm) 5mW input power; single frame

Measuring Terahertz Beam Profiles

Spiricon's Pyrocam pyroelectric cameras are an excellent tool for measuring THz lasers and sources. The coating of the crystal absorbs all wavelengths including 1μm to over 3000μm (0.1THz to 300THz). For THz sources the sensitivity of the Pyrocam is relatively low, at about 1.5mW/cm² at full output. With a S/N of 1000, beams of 30mW/cm² are easily visible.

In addition, with Spiricon's patented Ultracal baseline setting, multiple frames can be summed to "pull" a signal out of the noise. Summing 256 frames enables viewing of beams as low as 0.5-1.0mW/cm².

Broad Wavelength Response

The Pyrocam detector array has a very broadband coating which enables operation at essentially all IR and UV laser wavelengths. The curve ends at 100nm in the UV, but X-ray operation has been observed. Likewise the curve ends at 100μm in the far IR, but the camera has been used at >3000μm.

Thus you can use the Pyrocam in the near IR for Nd:YAG lasers at 1.06μm, and for infrared fiber optics at 1.3μm and 1.55μm. Use the Pyrocam for HF/DF lasers near 4μm and for Optical Parametric Oscillators from 1 μm to 10μm. It measures Free Electron Lasers between 193μm and 3000μm.

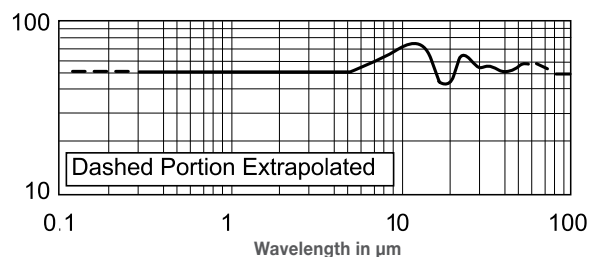

Spectral response of Pyrocam III detector array without window.

The Pyrocam™ is extremely useful in the UV from 13nm to 355nm for Excimer lasers and for tripled or quadrupled Nd:YAG lasers. The detector is stable under UV illumination, without the deterioration experienced by CCD cameras. (The pyroelectric detector operates in the visible spectrum, and can see the alignment HeNe used with CO₂ lasers. However, spurious response from the underlying silicon multiplexer creates undesirable performance, and the camera is not recommended for quantitative visible measurements).

BeamGage Image Analysis Software

Both Pyrocams come bundled with BeamGage, the state-of-the-art beam profiling system that performs rigorous data acquisition and analysis of laser beam parameters, such as beam size, shape, uniformity, divergence, mode content, and expected power distribution. Once the Pyrocam is connected to the PC and BeamGage is running, the software automatically detects the camera presence and is immediately ready to start taking images and displaying them on the monitor.

BeamGage is the industry's first beam profiling software to be newly designed, from scratch, using the most advanced tools and technologies. BeamGage is based on UltraCal™, Spiricon's patented baseline correction algorithm that helped establish the ISO 11146-3 standard for beam measurement accuracy.

BeamGage provides high accuracy results, guaranteeing the data baseline (zero-point reference) is accurate to 1/8th of a digital count on a pixel-by-pixel basis.

BeamGage permits the user to employ custom calculations for best fit to an individual application. These user-defined computations are treated like the standard calculations. They can be displayed on the monitor, logged with results, and included in hard-copy reports.

The system also allows the user to configure the displayed calculations, set-up the screen layout, and password-protect the configuration. This permits secure product testing, ensures security in production environments where plant floor personnel interface with the system, and assures the validity of the data for Statistical Process Control (SPC).

Hybrid Integrated Circuit Sensor

The Pyrocam consists of a LiTaO₃ pyroelectric crystal mounted with indium bumps to a solid-state readout multiplexer. This sensor, developed as the Company's core technology for the Pyrocam I, has proven to be the most rugged, stable, and precise IR detector array available. Light impinging on the pyroelectric crystal is absorbed and converted to heat, which creates charge on the surface. The multiplexer then reads out this charge. For use with short laser pulses, the firmware in the camera creates a very short electronic shutter to accurately capture the thermally generated signal.

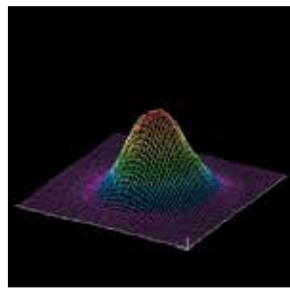

Er:YAG laser at 2.9µm.

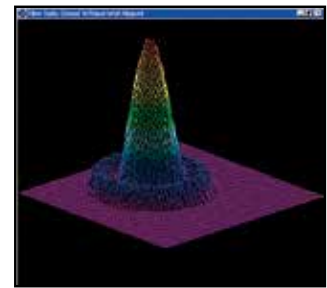

Output of infrared fiber optic.

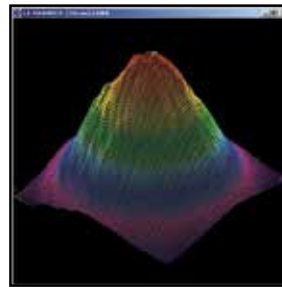

THz laser beam at 1.6THz (184µm).

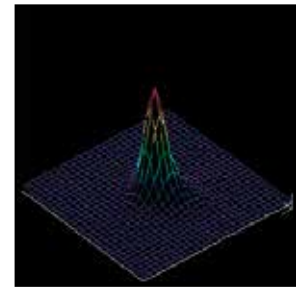

Free Electron laser at 100µm.

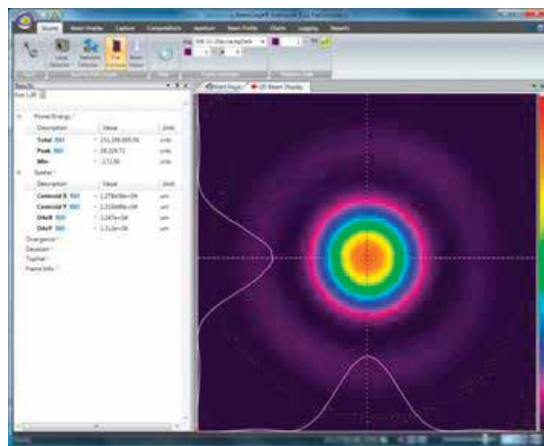

BeamGage recognizes the Pyrocam IIIHR & IV and allows you to quickly start analyzing your laser beam

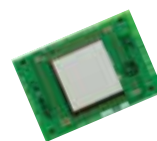

Pyrocam IIIHR 12.8X12.8mm array

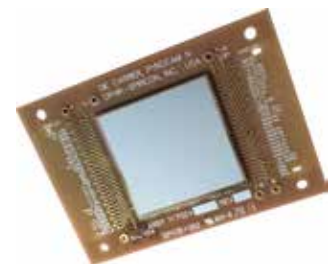

Pyrocam IV 25mm X 25mm array

State-Of-The-Art Electronics

The camera features a high resolution A/D converter which digitizes deep into the camera noise. This enables reliable measurement and analysis of both large signals and low level signals in the wings of the laser beam. High resolution digitizing

also enables accurate signal summing and averaging to pull weak signals out of noise. This is especially useful with fiber optics at 1.3 μ m and 1.55 μ m, and in thermal imaging.

Applications Of The Pyrocam™ IIIHR

The Pyrocam is an ideal camera for use in scientific laboratory investigation of laser beams. This includes physics, chemistry, and electronic system designs. As an example, the photos on the right side show a research CO₂ laser and a research Nd:YAG laser, both with cavity misalignment.

The camera is also useful in product engineering of CO₂ and other infrared lasers. The Pyrocam is an integral part of the assembly lines of many CO₂ laser manufacturers. Integrators of systems are using the Pyrocam sensor to make sure that optical systems are aligned and operating properly.

There are many medical applications of the Pyrocam, such as the analysis of excimer lasers used for eye surgery. In many cases these lasers need alignment to ensure that the eye surgery is performed as expected. Other medical IR lasers perform dermatology, for which the uniformity of the beam profile must be assured.

Fiber optic communications, at 1.3 μ m and 1.55 μ m make significant use of the Pyrocam for analyzing the beams being emitted, as well as analyzing properties of the beams before launching them into fibers. The greater stability of the Pyrocam make it a good choice over other cameras operating at telecommunication wavelengths.

The Pyrocam is becoming an essential tool in the maintenance of industrial infrared lasers, especially CO₂. The Pyrocam replaces non-electronic mode burns and acrylic blocks by providing higher definition electronic recording of

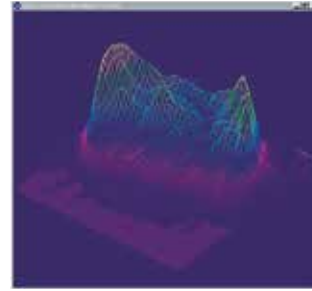

CO₂ laser with cavity misalignment.

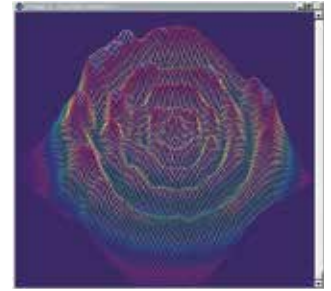

Nd:YAG laser with cavity misalignment.

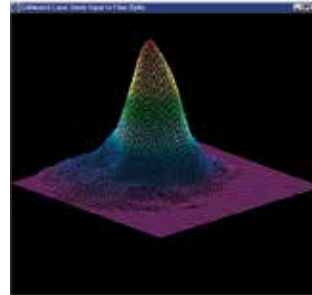

CO₂ laser with cavity misalignment.

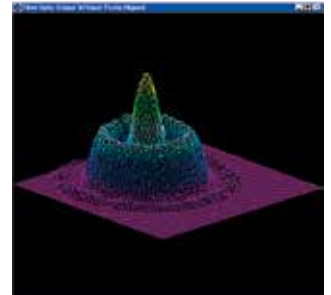

Nd:YAG laser with cavity misalignment.

data, and analysis of short term fluctuations. The Pyrocam is superior to other electronic methods of measuring CO₂ lasers because the entire beam can be measured in a single pulse, and additional measurements made in real-time. This ensures that the beam did not change during the measurement.

Detector Damage Threshold

The Pyrocam sensor is capable of operation with intensities about 100 times greater than CCD cameras. This makes the camera ideal for use with high power lasers, as less attenuation is required. Nevertheless, pulsed lasers with fluence too high can evaporate the absorbing front electrode.

As shown the damage threshold increases with pulse width. With nanosecond and longer pulses, detector saturation occurs before damage.

With shorter pulses it helps to increase the camera amplifier gain so that electronic saturation occurs before damage.

The sensor can be damaged by excessive CW power, which causes crystal cracking. Very few Pyrocam detectors have been damaged by CW power, but some have been ablated by high peak pulse energy.

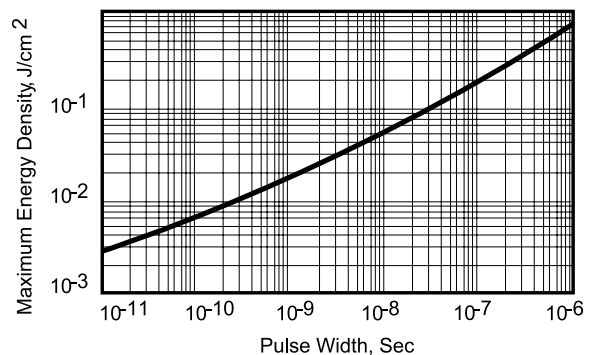

Pulsed damage threshold of pyroelectric detector coating.